



www.skyjacker.com

2002 - 2006 Chevy Avalanche
2500 4WD
6" Suspension Lift
Installation Instructions

REQUIRED TOOL LIST:

- * Metric / Standard Wrenches & Sockets
- * Allen Wrenches
- * Assorted Drill Bits
- * Floor Jack
- * Jack Stands
- * Measuring Tape
- * Torsion Bar Tool
- * Torque Wrench
- * Transmission Jack
- * Reciprocating Saw
- * Grinder



Before beginning the installation, thoroughly & completely read these instructions & the enclosed driver's WARNING NOTICE. Affix the WARNING decal in the passenger compartment in clear view of all occupants. Please refer to the Parts List to insure that all parts & hardware are received prior to the disassembly of the vehicle. If any parts are found to be missing, contact SKYJACKER® Customer Service at 318-388-0816 to obtain the needed items. If you have any questions or reservations about installing this lift kit, contact SKYJACKER® Technical Assistance at 318-388-0816.

Make sure you park the vehicle on a level concrete or asphalt surface. Many times a vehicle is not level (side-to-side) from the factory & is usually not noticed until a lift kit has been installed, which makes the difference more visible. Using a measuring tape, measure the front & rear (both sides) from the ground up to the center of the fender opening above the axle. Record this information below for future reference.

Driver Side Front: _____ Passenger Side Front: _____

Driver Side Rear: _____ Passenger Side Rear: _____

IMPORTANT NOTES:

- Minor modifications are required on all Duramax diesel models.
- This lift is determined from the amount of lift to the front of the vehicle, while only lifting the rear to a position level with the front.
- If larger tires (10% more than the stock diameter) are installed, speedometer recalibration will be necessary. Contact your local GM dealer or an authorized dealer for details.
- After installation, a qualified alignment facility is required to realign the vehicle to the OEM specifications.

Component Box Breakdown:

Part #: C9671A

Item #	Description	Qty
GM256-LB	GM 2500 6" LEFT KNUCKLE	1
GM256-RB	GM 2500 6" RIGHT KNUCKLE	1
C967TBD-S	GM 2500 6" T/BAR BRACKET	2

Item #	Description	Qty
HB-C967-TBB	HDWR BAG: GM 6" T/BAR BRKTS	1
I-C9671	INST SHEET: C9671	1

Hardware Bag Breakdown:

Part # HB-C967-TBB

Item #	Description	Qty
SP3445	GM TORSION BAR BUSHING	4
TBSC967	GM TORSION BAR SLEEVE	2
12X112FTB	1/2 X 1 1/2 FINE THREAD BOLT	8

Item #	Description	Qty
12FTN	1/2-20 FINE N/I LOCK NUT	8
12SAEW	1/2 SAE WASHER	16

Component Box Breakdown:

Part #: C9671B

Item #	Description	Qty
C9682FCM-B	GM 2500 FRONT X-MEMBER	1
C9682RCM-B	GM 2500 REAR X-MEMBER	1
C9682BSB-D	GM 2500 DRV BUMP STOP BRKT	1
C9682BSB-P	GM 2500 PAS BUMP STOP BRKT	1
C9682FDB-B	GM 2500 FRONT DIFF BRACKET	1
C9682PS-S	GM 2500 PASS DIFF BRACKET	1
C9682SKD-S	GM 2500 DIFF SKID PLATE	1
C968CVS-D	GM 2500 DRIVER CV SPACER	1
C968CVS-P	GM 2500 PASS CV SPACER	1

Item #	Description	Qty
CBL2500	GM 2500 CARR BRG LWRG KIT	1
RB45	4.5" REAR BLOCK	2
58X234X1212U	5/8 X 2 3/4 X 12 1/2 U-BOLT	4
HB-C9682-CM	HDWR BAG: GM 2500 X-MEMBR	1
HB-C968-CVS	HDWR BAG: C968 CV SPACERS	1
HB-C9682FDB	HDWR BAG: C968 FRT DIFF BRK	1
HB-C968-SBL	HDWR BAG: SWAY BAR-MISC	1
HB-C968-SKD	HDWR BAG: C968 DIFF SKID PLT	1
HB-58	HDWR BAG: 5/8" N/I LOCK NUT	1

Part # CBL2500

Item #	Description	Qty
CBL255-B	CARR BRG LWRG BRACKET	1
SP250	1/4" SHIM PLATE, 1/2" HOLE	2
38X312FTB	3/8 X 3 1/2 FINE THREAD BOLT	2

Item #	Description	Qty
38FTN	3/8 FINE N/I LOCK NUT	2
38SAEW	3/8 SAE WASHER	4

Hardware Bag Breakdown:

Part # HB-C9682-CM

Item #	Description	Qty
58X5FTB	5/8 X 5 FINE THREAD BOLT	2
58X512FTB	5/8 X 5 1/2 FINE THREAD BOLT	2
58FTN	5/8 FINE N/I LOCK NUT	4
58SAEW	5/8 SAE WASHER	8

Item #	Description	Qty
716X112FTB	7/16 X 1 1/2 FINE THREAD BOLT	6
716FTN	7/16 FINE N/I LOCK NUT	6
716SAEW	7/16 SAE WASHER	12

Part # HB-C968-CVS

Item #	Description	Qty
10MMX50MMB	10MM X 50MM METRIC BOLT	6
10MMX100MMB	10MM X 100MM METRIC BOLT	6

Item #	Description	Qty
LT100	NUTS N' BOLTS 427 1 ML TUBE	2

Part # HB-C9682FDB

Item #	Description	Qty
10MMX60MMB	10MM X 60MM METRIC BOLT	4
38SAEW	3/8 SAE WASHER	4
916X112FTB	9/16 X 1 1/2 FINE THREAD BOLT	2
916FTN	9/16 FINE N/I LOCKNU	2
916SAEW	9/16 SAE WASHER	4

Item #	Description	Qty
2433	BUSHING IFS GM DIFF	2
C968SHIM	GM SHIM-PASS DIFF BRKT	1
CS2375	CRUSH SLEEVE / 2.375"	1
LT100	NUTS N' BOLTS 427 1 ML TUBE	1

Part # HB-C968-SBL

Item #	Description	Qty
6MMX12SHB	6MM X 12MM METRIC BOLT	6
38X312FTB	3/8 X 3 1/2 FINE THREAD BOLT	2
38FTN	3/8 FINE N/I LOCK NUT	2
38SAEW	3/8 SAE WASHER	4

Item #	Description	Qty
38HDCC-S	3/8" CABLE CLAMP	6
SBE1125-S	FRONT SWAY BAR ENDLINK	2
SBE-CBSH	END LINK BUSHING	2

Part # HB-C968-SKD

Item #	Description	Qty
516X1CARB	5/16 X 1 CARRIAGE BOLT	2
516X1FTB	5/16 X 1 FINE THREAD BOLT	2
516CTN	5/16 COARSE N/I LOCK NUT	2

Item #	Description	Qty
516FTN	5/16 FINE N/I LOCK NUT	2
516LW	5/16 LOCK WASHER	2
516SAEW	5/16 SAE WASHER	6

Part # HB-58

Item #	Description	Qty
58FTN	5/8 FINE N/I LOCK NUT	8

Attention all Duramax diesel models:

All models equipped with the Duramax Diesel may require modifications to the torque converter housing.

Before installation of the suspension lift, the lower driver side of the torque converter housing must be cut off. Photo # 1 shows the pinion yoke in contact with the housing with the lift installed, before modification. Photo # 2 shows the housing after modifications. The housing must be trimmed off past the OEM casting dowel hole.

Some models will require that the differential be ground for clearance of the switch located on the side of the oil pan. (See Photo # 3) The differential may also have to be ground for clearance of the oil pan itself. (See Photo # 4)



Front Installation:

1. With the vehicle on flat level ground set the emergency brake & block the rear tires / wheels. Place a floor jack under the lower control arm's front cross member & raise the vehicle. Place jack stands under the frame rails, behind the front wheel wells & lower the frame onto the stands.
2. Remove the front OEM skid plates located in front of & under the front differential using a 15mm socket. (See Photo # 1)

Warning: Be extremely careful when loading or unloading the torsion bars; there is a tremendous amount of stored energy (load pressure) in the torsion bars. Keep your hands & body clear of the adjuster arm assembly & puller tool in case anything slips or breaks.

Note: A torsion bar removal tool is required for SAFE REMOVAL / INSTALLATION of the torsion bars. This torsion bar removal tool can be purchased from a GM dealer or auto parts store.

3. Locate the torsion bar adjuster bolt on the bottom of the rear cross member, measure & record the length of the torsion bar adjusting bolt that is exposed below the nut & remove the torsion bar adjusting bolt. Apply a small amount of lubricating grease to the torsion bar removal tool threads & the shaft-to-adjuster arm contact point. Position the torsion bar removal tool & load adjuster arm until the adjuster nut can be removed from the cross member. With the torsion bar unloaded, slide it further forward into the lower control arm. If the torsion bar seems lodged, use a hammer & punch through the hole in back of the cross member. When the torsion bar shifts forward, the adjuster will fall free. (See Photo # 2) Repeat this process on the opposite side of the vehicle.
4. With the torsion bars removed from the rear cross member, remove the torsion bar cross member using 21mm socket. With the cross member removed, remove the torsion bars from the vehicle. **Note:** Mark the driver & passenger side torsion bars for reinstallation.
5. Remove the front tires / wheels. Remove the OEM front shocks using a 21mm socket & 15mm wrench & remove the OEM front sway bar links using a 13mm wrench.
6. Remove the tie rod end nut from the OEM steering knuckle using a 21mm socket. Remove the tie rod end from the steering knuckle by striking the steering knuckle to dislodge the tie rod end. **Note:** Be careful not to damage the tie rod end. (See Photo # 4)



Photo # 1



Photo # 2



Photo # 3

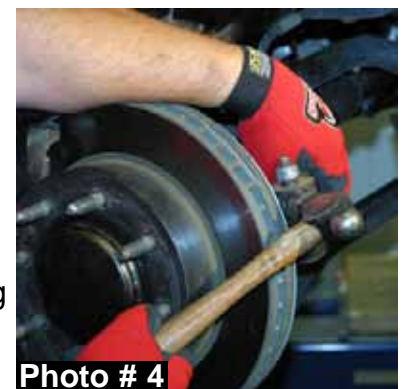

Photo # 4

7. Disconnect the OEM ABS line at the top of the frame rail. Remove the OEM brakeline retaining bracket from the top of the OEM steering knuckle using a 10mm wrench. **Note:** It will not be necessary to disconnect the banjo fitting at the OEM brake caliper. Remove the caliper using a 21mm socket. Then wire the brake caliper out of the way so that there is no stress on the OEM brake line. With the brake caliper removed, remove the OEM brake rotor. (See Photo # 5)



8. Remove the OEM outer axle nut dust cover to allow access to the OEM outer axle nut. Remove the OEM outer axle nut & washer using a 1 7/16" socket. (See Photo # 6)



9. Mark the OEM cv-axle prior to removal so the cv-axle can be reinstalled the same way as removed. **Note:** Mark the driver & passenger side cv-axles for reinstallation. Remove the cv-axles from the front differential using a 15mm socket & remove the cv-axles. (See Photo # 7)

10. Remove the OEM upper & lower a-arm ball joints from the OEM steering knuckle using a 18mm & 24mm socket. It may be necessary to strike the steering knuckle to allow the ball joints to dislodge. **Note:** Be careful not to damage the ball joints. Remove the OEM steering knuckle from the vehicle.

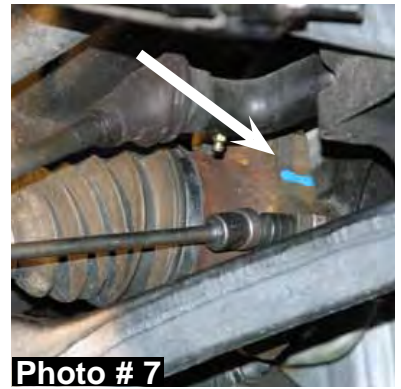

11. Remove the OEM hub bearing from the OEM steering knuckle using a 15mm socket & remove the OEM inner o-ring from the steering knuckle. **Note:** The OEM o-ring will be reused later in the installation process. (See Photo # 8)



12. Remove the lower a-arm from the frame using a 24mm socket & 18mm wrench. (See Photo # 9)

13. Disconnect the OEM front drive shaft using a 11mm wrench. **Note:** Mark the u-joint & yoke at the differential. The drive shaft **must** be installed the same way during reinstallation. Failure to

realign the u-joint & yoke in the exact same point could result in vibration after install. Do not remove the drive shaft, simply strap it out of the way. GM front drive shafts are balanced on each vehicle due to driveline vibrations. It is **very** important that the drive shaft is reinstalled the same as OEM. (See Photo # 10)

14. Locate the OEM rear two piece differential cross member & locate the point on the driver side where the cross member is welded to the frame. It will be necessary to grind off the welds so the cross member can be removed. (See Photo # 11)
15. With the welds ground off, remove the cross member mounting bolts using a 18mm wrench & remove the rear cross member assembly. (See Photo # 12)
16. While supporting the front differential with a transmission jack, remove the passenger side differential mounting bolts using a 21mm socket. Disconnect the actuator line from the passenger side of the front differential. (See Photo # 13)
17. Remove the driver side upper differential bolt using a 21mm socket. Disconnect the vacuum hose on the driver side of the front differential & remove the differential using a transmission jack. (See Photo # 14)
18. On the passenger side differential tube pad, locate the rearward mounting hole. Measure 1/2" from the outside edge of the hole to the outside edge of the mount & make a mark. Using a reciprocating saw or other similar tool, cut along the mark. (See Photos # 15 & # 16)
19. Locate the rear cross member mount on the driver side & passenger side frame & grind the front outside edge smooth. (See Photo # 17)

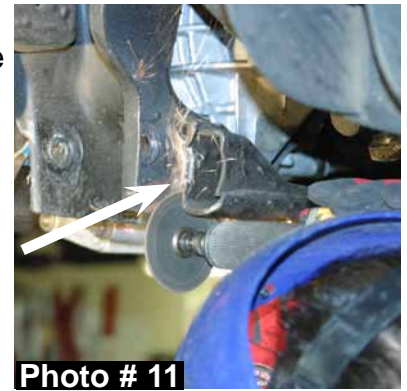

20. Place the new Skyjacker upper a-arm extension stop shim on the upper portion of the OEM a-arm stop bracket & weld in place. (See Photo # 18)

21. Locate the upper mount of the differential & make a mark across the lower portion of the differential mount. Using a reciprocating saw or other similar tool, remove the OEM upper differential mount. **Note:** Be extremely careful not to cut into the differential housing. (See Photo # 19) Use a grinder or other similar tool to clean up any imperfections or uneven cuts. (See Photo # 20) Some models will require the removal of the lower differential casting tab for rear cross member clearance. (See Photo # 21)

22. Insert the new Skyjacker poly bushings (SP3445) & sleeve into the eyelet of the new Skyjacker driver side differential bracket. Install the driver side differential bracket to the OEM differential using the supplied 10mm x 60mm bolts & washers. (See Photo # 22) **Note:** Use the supplied thread lock compound when installing these differential bolts.

23. Install the new Skyjacker passenger side differential bracket. The new bracket will install with the open end to the inside & the longest end on top. Use the OEM hardware to attach the upper part of the new bracket to the OEM mount. (See Photo # 23)

24. Support the front differential & attach the differential to the new passenger side bracket using the supplied 9/16" x 2" coarse thread bolts, washers, & nuts. **Note:** Be sure to install the support shim under the rear differential mount. This piece is used to support the mount that was cut earlier. (See Photo # 24)

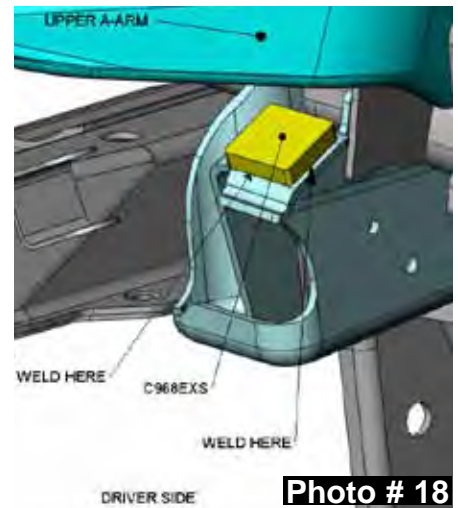

Arrow shows the support shim from Step # 24. Found in hardware bag Part # HB-C9682FDB



25. Remove the OEM bump stops from the frame using a 15mm socket. Enlarge the two OEM bump stop bracket bolt holes, using a 7/16" drill bit. Install the new Skyjacker bump stop bracket using the supplied 7/16" x 1 1/2" fine thread bolts, washers, & nuts. Center punch the remaining hole & drill using a 7/16" drill bit. Install the remaining 7/16" x 1 1/2" fine thread bolt, washers, & nut. (See Photo # 25)



26. Attach the OEM bump stop to the new Skyjacker bump stop brackets using the OEM hardware.

27. Install the new Skyjacker rear cross member using the supplied 5/8" x 5 1/2" fine thread bolts, washers, & nuts at the upper mount. (See Photo # 26)



28. Attach the rear of the differential to the new rear cross member using the OEM hardware. Push the differential back toward the rear of the vehicle & tighten the bolts. Reattach the OEM front vacuum line & front actuator line.

29. Install the new Skyjacker front cross member using the supplied 5/8" x 5" fine thread bolts, washers, & nuts at the upper mount. (See Photo # 27)



30. Attach the driver front differential bracket to the new front cross member using the OEM hardware from the upper differential mount.

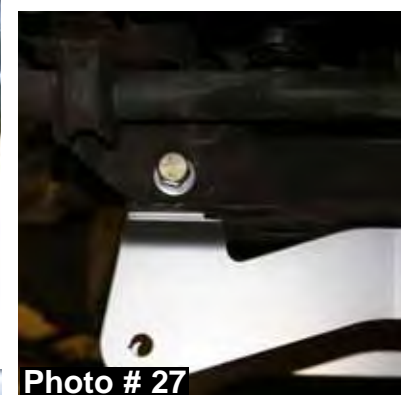

31. Install the lower a-arms to the new cross members using the OEM hardware. (See Photo # 28)

32. Reinstall the OEM o-ring to the new Skyjacker steering knuckle. From the OEM position, rotate the OEM hub bearing assembly 90 degrees toward the front of the vehicle & attach using the supplied thread locking compound & OEM hardware. Verify that the OEM ABS sensor is now pointing forward instead of up as it was OEM & torque the flange bolts to 130 ft. lbs. **Note:** The OEM dust shield will not be reused with the new steering knuckle. (See Photo # 29)



33. Install the new Skyjacker steering knuckles. Attach the upper & lower a-arms to the new steering knuckle using the OEM hardware. The OEM outer tie rod end will install from the top instead of from the bottom as it was OEM. (See Photo # 30)

34. Reinstall the OEM brake rotors & brake calipers. Torque the brake caliper bolts to 70 ft. lbs.
I-C9671

35. Install the OEM driver & passenger side cv-axles. Use the new Skyjacker 3.063" cv-axle spacer on the DRIVER side & use the new Skyjacker 15/16" wide cv-axle spacer on the PASSENGER side. The new cv-axle spacers will install between the OEM cv-axle & differential with the male end against the differential. Use the supplied 10mm x 100mm bolts on the driver side & the 10mm x 50mm bolts on the passenger side. **Note:** Use the supplied thread lock compound on these bolts & torque the bolts to 45 ft. lbs. (See Photo # 31)



Photo # 31

36. Reinstall the OEM cv-axle retaining nuts & dust covers.

Passenger side shown with one 15/16" cv-spacer.

37. Install the new Skyjacker front differential skid plate to the new front & rear cross members using the supplied 5/16" x 1" bolts, washers, & nuts. (See Photo # 32)



Photo # 32

38. Attach the OEM ABS lines to the upper a-arm using the supplied cable clamp & OEM hardware. (See Photo # 33) Attach the OEM ABS lines & brake lines to the rear of the new steering knuckles using the supplied cable clamps & 6mm x 12mm bolts. (See Photo # 34)



Photo # 33

39. Install the new Skyjacker front shocks using the OEM lower bolts. (See Photo # 35) **Note:** For ease of installing the new front shocks into the lower front shock mount, it may be necessary to grind an 1/8" off each side of the new polyurethane shock eye bushing.



Photo # 34

40. Install the new Skyjacker sway bar end link bushing (Part # SBECBSH) on the stud of the pivoting end of the new Skyjacker sway bar end link with the larger diameter end facing the boot of the sway bar end link. Align the new sway bar end link bushing with the OEM mounting location of the OEM a-arm & install the new Skyjacker sway bar end link. **Note:** Install the new sway bar end link with the pivoting end at the a-arm. (See Photo # 36)

41. Reinstall the OEM front drive shaft being sure to reinstall in the exact same position with the marks made to the u-joint & yoke from Step # 13. (See Photo # 37)



Photo # 36



Photo # 37

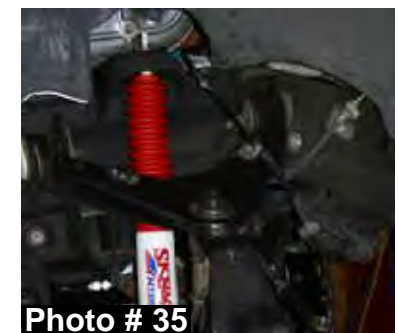

Photo # 35

42. Install the new Skyjacker torsion bar drop brackets by aligning the new brackets with the rivets on the frame. Position the new brackets so there is equal distance between the bolt holes in the bracket & the rivets in the frame. Secure with a c-clamp, mark, & drill the holes using a 17/32" drill bit. Once drilled, attach the new bracket to the frame using the supplied 1/2" x 1 1/2" fine thread bolts, washers, & nuts. At this point, the center of the new bracket should be lined up with the center of the OEM bushing on the frame. With the new brackets installed, install the supplied poly bushings & sleeves into the drop bracket. Reinstall the OEM torsion bar cross member using the OEM hardware. (See Photo # 38)



43. Reinstall the OEM torsion bars. **Note:** Be sure to install the OEM adjuster bolts to the same length as OEM. (See Photo # 39)



If installing a new Skyjacker dual steering stabilizer Part # 7298, see those instructions at this time.



44. On vehicles equipped with an OEM rear carrier bearing, it will be necessary to lower the carrier bearing. Remove the OEM carrier bearing using a 15mm socket. **Note:** It is recommended to place a strap around the drive shaft to keep it from moving. (See Photo # 40)

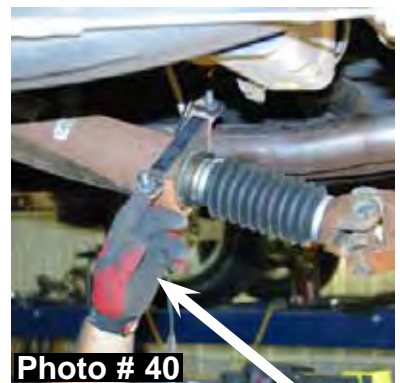

45. Once the nuts are removed, knock out the OEM studs & install the new Skyjacker carrier bearing lowering spacer using the supplied 3/8" x 3 1/2" fine thread bolts, washers, & nuts. **Note:** Install the new carrier bearing lowering spacer using the 2" side. (See Photo # 41)



46. Reinstall the front tires / wheels & lower the vehicle to the ground. At this time, check all bolts & hardware for proper installation & torque.

Rear Installation:

47. Block the front tires / wheels, raise the rear of the vehicle, & support the frame rails using jack stands.
48. Remove the OEM rear shock using a 21 mm socket. (See Photo # 42)
49. While supporting the rear axle with a floor jack, remove the OEM rear u-bolts using a 15/16 socket. If installing blocks, proceed to Step # 52.



REAR SPRING INSTALLATION:

50. Remove the OEM leaf spring eye bolts using a 15/16" socket & remove the OEM rear leaf springs. (See Photo # 43) The new Skyjacker rear leaf springs are equipped with a degree shim attached to the bottom of each leaf spring to correct pinion angle. Install the new leaf spring with the thick end of the shim towards the rear of the vehicle. Insert the OEM leaf spring eye bolts. **(Do Not Tighten at This Time!)** It may be necessary to disconnect the emergency brake cable on the driver side frame rail to allow the axle to come down far enough to install the new leaf spring & reattach once the new leaf spring is installed.
51. Attach the new Skyjacker leaf spring to the axle using the supplied u-bolts. **Note:** Be sure the center tie bolt seats into the axle pad. Torque the new u-bolts to 100-110 Ft. Lbs. Proceed to Step # 53.



BLOCK INSTALLATION:

52. Install the new Skyjacker rear blocks using the supplied u-bolts. **Note:** Install the new rear blocks with the tallest portion toward the rear of the vehicle. Slowly let the weight down onto the new rear blocks, being sure that the center pin in the rear block is inserted into the axle pad correctly & that the leaf spring center tie bolt head seats into the hole in the new rear block. Torque the u-bolts to 100-110 ft. lbs.
53. Install the new Skyjacker rear shocks using the OEM hardware. (See Photo # 44)
54. Reinstall the rear tires / wheels, lower the vehicle to the ground, & torque the leaf spring eye bolts to 50 ft. lbs. At this time, check all bolts & hardware for proper installation & torque.



FINAL NOTES:

- After the installation is complete, double check that all nuts & bolts are tight. Refer to the following chart for the proper torque specifications. (Do not retighten the nuts & bolts where thread lock compound was used.)
- With the vehicle placed on the ground, cycle the steering lock to lock & inspect the steering, suspension, brake lines, front & rear drivelines, fuel lines, & wiring harnesses for proper operation, tightness, & adequate clearance.
- Have the headlights readjusted to the proper settings.
- Have a qualified alignment center realign the vehicle to the OEM specifications.
- Retorque all the bolts after the first 100 miles.

<u>TORQUE SPECIFICATIONS</u>					
<u>INCH SYSTEM</u>			<u>METRIC SYSTEM</u>		
Bolt Size	Grade 5	Grade 8	Bolt Size	Class 8.8	Class 10.9
5/16	15 FT LB	20 FT LB	6MM	5 FT LB	9 FT LB
3/8	30 FT LB	35 FT LB	8MM	18 FT LB	23 FT LB
7/16	45 FT LB	60 FT LB	10MM	32 FT LB	45 FT LB
1/2	65 FT LB	90 FT LB	12MM	55 FT LB	75 FT LB
9/16	95 FT LB	130 FTLB	14MM	85 FT LB	120 FT LB
5/8	135 FT LB	175 FT LB	16MM	130 FT LB	165 FT LB
3/4	185 FT LB	280 FT LB	18MM	170 FT LB	240 FT LB

- **The above specifications are not to be used when the bolt is being installed with a bushing.**

Seat Belts Save Lives, Please Wear Your Seat Belt.



Jesus Christ Died For You.

John 3:16

For God so loved the world that He gave His only Son, so that everyone who believes in Him should not perish, but have everlasting life.
Romans 3:23

For all have sinned; all fall short of God's glorious standard.
Ephesians 2:8

God saved you by his special favor when you believed. And you can't take credit for this; it is a gift from God.
Psalms 18:2

The Lord is my Rock, my fortress, and my savior; my God is my Rock, in whom I find protection. He is my shield, the strength of my salvation, and my stronghold.
Romans 10:9-10

That if you shall confess with thy mouth the Lord Jesus, and shall believe in your heart that God hath raised him from the dead, you shall be saved. For with the heart man believeth unto righteousness; and with the mouth confession is made unto salvation.

Pray This Simple Prayer:

God, I come to You admitting I have sinned against You and I need you to take control of my life. The Bible says anyone who calls on the name of the Lord will be saved. I am calling on You, Jesus. I ask that You come live in my heart and be the Lord over my life today. I do believe You died on the cross for me and came back to life to give me life! Thank You, Lord Jesus for a new life in You!

Now, go and tell somebody about your new life in Jesus, get a Bible, begin to read it, and go to a Bible believing church.

If you would like someone to pray with you, call Kenneth Copeland Ministries anytime at 800-600-7395.

To listen to commercial free Christian radio on the web, go to www.887fm.org

Jesús murió por ti.

Juan 3:16

"Porque tanto amó Dios al mundo, que dio a su Hijo unigénito, para que todo el que cree en él no se pierda, sino que tenga vida eterna."
Romanos 3:23

"Pues todos han pecado y están privados de la gloria de Dios."
Efesios 2:8

"Porque por gracia ustedes han sido salvados mediante la fe; esto no procede de ustedes, sino que es el regalo de Dios."
Salmos 18:2

"El Señor es mi roca, mi amparo, mi libertador; es mi Dios, el peñasco en que me refugio. Es mi escudo, el poder que me salva, ¡mi más alto escondite!"
Romanos 10:9-10

"9 Que si confi esas con tu boca que Jesús es el Señor, y crees en tu corazón que Dios lo levantó de entre los muertos, serás salvo. 10 Porque con el corazón se cree para ser justifi cado, pero con la boca se confi esa para ser salvo."

Ahora dí esta simple oración:

Dios, vengo a Ti y admito que he pecado contra Ti, necesito que tomes el control de mi vida. La Biblia dice que todo aquel que invoca el nombre del Señor escapará con vida. En este momento yo clamo ante Ti, Jesús; te pido que vengas a vivir en mi corazón y que tomes el control de mi vida. ¡Yo creo que tu moriste en la cruz y resucitaste para darme vida! ¡Gracias Señor Jesús, por una nueva vida que tengo en Ti! Amen.

Ahora ve y dile a alguien sobre la nueva vida que tienes en Cristo. Compra una Biblia y empieza a leerla. Busca una Iglesia que cree en la Biblia y hazte parte de esa Iglesia.

Si te gustaría orar con alguien, puedes llamar a este número 800-600-7395

Puedes ir a este sitio de Internet para escuchar música Cristiana sin anuncios, www.887fm.org

Check out our favorite ministries at:

www.innministries.org

www.familychurch.org

www.kcm.org

